**DE**

Montageanleitung

**ELEKTRISCHER ANTRIEBSMOTOR MIT GETRIEBE**

Rotationswärmetauscher

Deutsch | Änderungen vorbehalten!

**GB**

Installation instructions

**ELECTRIC DRIVE MOTOR WITH GEARBOX**

Rotary heat exchanger

English | Subject to modifications!

**ES**

Instrucciones de montaje

**MOTOR ELÉCTRICO DE ACCIONAMIENTO CON ENGRANAJES**

Recuperador de calor rotativo

Español | ¡Con reserva de modificaciones!

**FR**

Notice de montage

**MOTEUR ÉLECTRIQUE AVEC TRANSMISSION**

Récupérateur de chaleur rotatif

Français | Sous réserve de modifications techniques !

**RU**

Руководство по монтажу

**ЭЛЕКТРИЧЕСКИЙ ПРИВОДНОЙ ДВИГАТЕЛЬ С  
КОРОБКОЙ ПЕРЕДАЧ**

Роторный теплообменник

Русский | Возможны изменения!



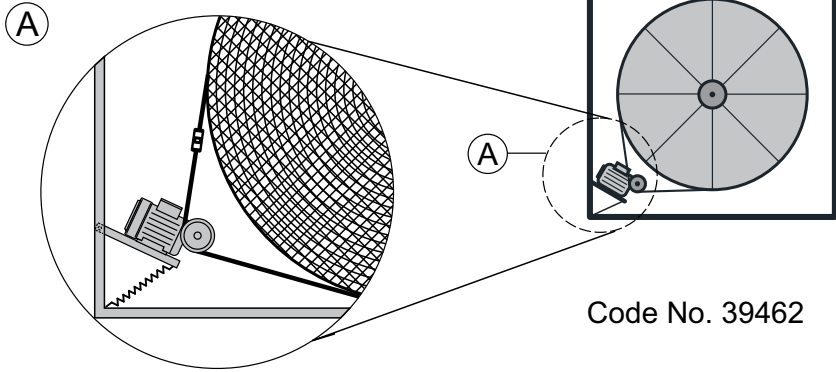

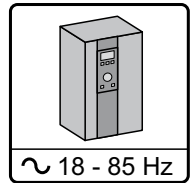
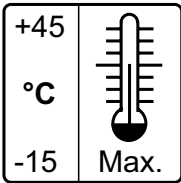

Code No. 39462

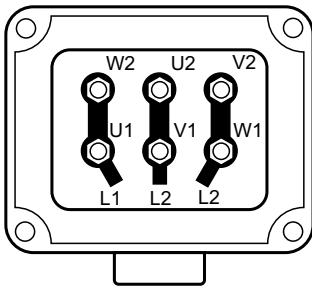

 3 x 230 V



 3 x 400 V

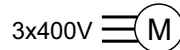
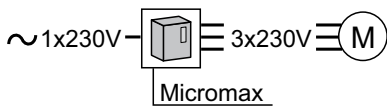
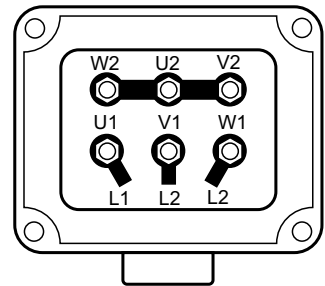



WOLF GmbH / Postfach 1380 / D-84048 Mainburg  
Tel. +49.0.87 51 74- 0 / Fax +49.0.87 51 74- 16 00 / [www.WOLF.eu](http://www.WOLF.eu)